

Fig.1

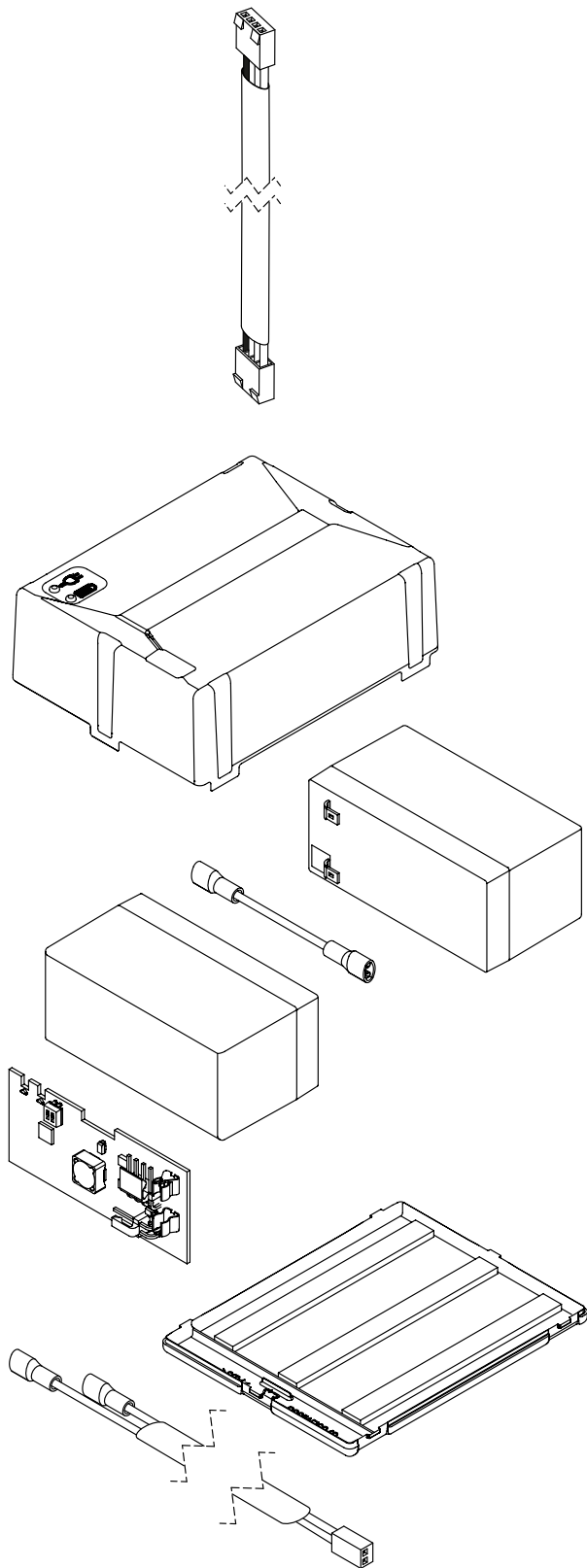

Fig.2

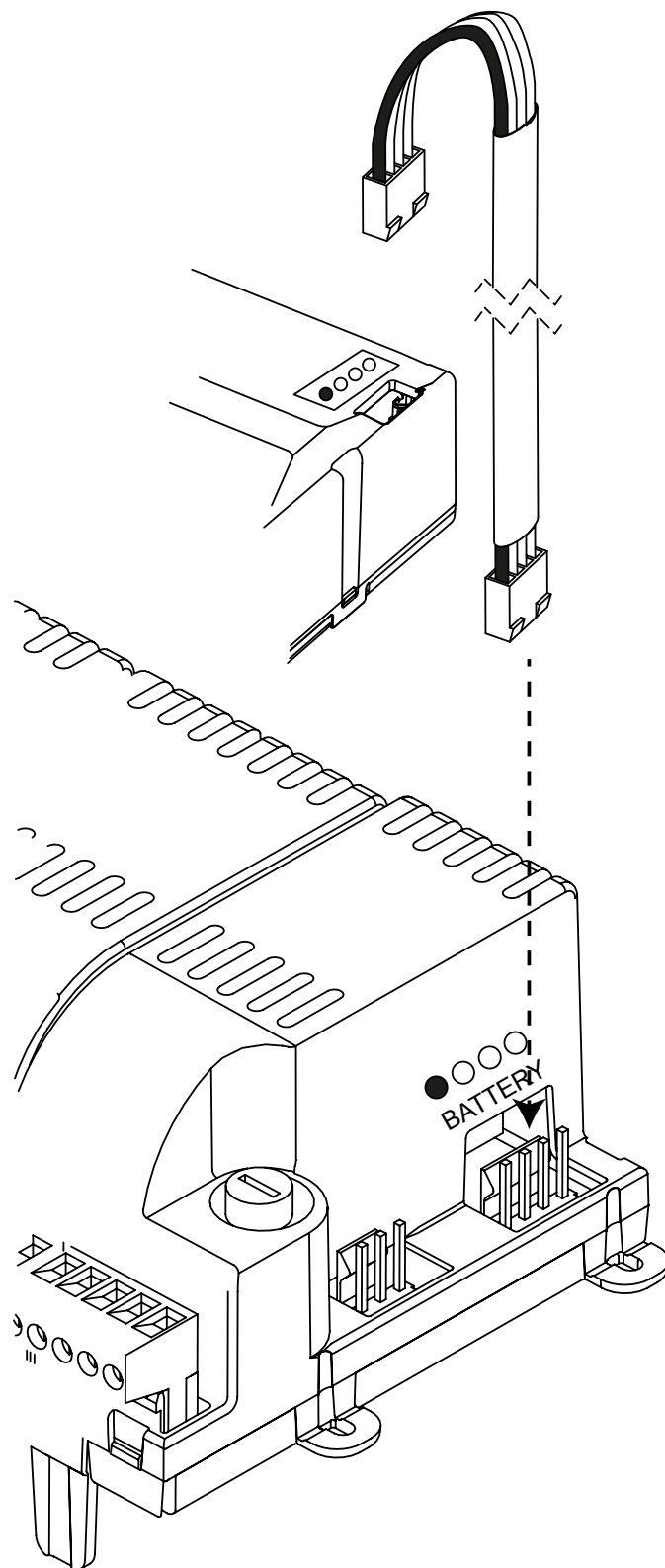















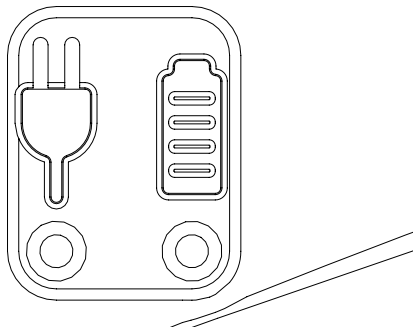

Fig.3

		IT	EN	FR	ES	DE	PT	PL
GREEN	RED							
		BATTERIA IN CARICAMENTO	BATTERY CHARGING	CHARGE DE LA BATTERIE	CARGA DE LA BATERÍA	BATTERIE AUFLADUNG	CARREGAMENTO DA BATERIA	ŁADOWANIE BATERII
		BATTERIA CARICATA	BATTERY CHARGED	BATTERIE CHARGÉE	BATERÍA CARGADA	BATTERIE GELADEN	BATERIA CARREGADA	BATERIA JEST NAŁADOWANA
		ALIMENTATA A BATTERIA	BATTERY POWERED	ALIMENTÉ PAR BATTERIE	ALIMENTACIÓN POR BATERÍA	BATTERIE GESPEIST	ALIMENTADO POR BATERIA	ZASILANIE BATERYJNE
		LIVELLO BATTERIA MINIMO	BATTERY LEVEL MINIMUM	NIVEAU DE BATTERIE AU MINIMALE	NIVEL MÍNIMO DE BATERÍA	MINDESTLADEZUSTAND DER BATTERIE	NÍVEL DA BATERIA MÍNIMO	MINIMALNE POZIOM BATERII
		BATTERIA DANNEGGIATA	DAMAGED BATTERY	BATTERIE ENDOMMAGÉE	BATERÍA DAÑADA	BESCHÄDIGTEN BATTERIE	BATERIA DANIFICADA	USZKODZENIE BATERII
		NON COLLEGATO O SCARICO	NOT CONNECTED OR DISCHARGE	PAS CONNECTÉ OU DÉCHARGE	NO CONECTADO O DESCARGADA	NICHT ANGESCHLOSSEN ODER LEER	NÃO CONECTADO OU CORRIMENTO	NIE PODŁĄCZONY LUB WYŁADOWCZE
		VELOCITÀ MOTORI	MOTORS SPEED	VITESSE MOTEUR	VELOCIDAD MOTOR	GESCHWINDIGKEIT MOTOR	VELOCIDADE MOTOR	PREDKOŚĆ SILNIKA





LEGEND	
	OFF
	ON
	FLASH

Fig.4



DICHIARAZIONE DI CONFORMITA'

DECLARATION OF CONFORMITY

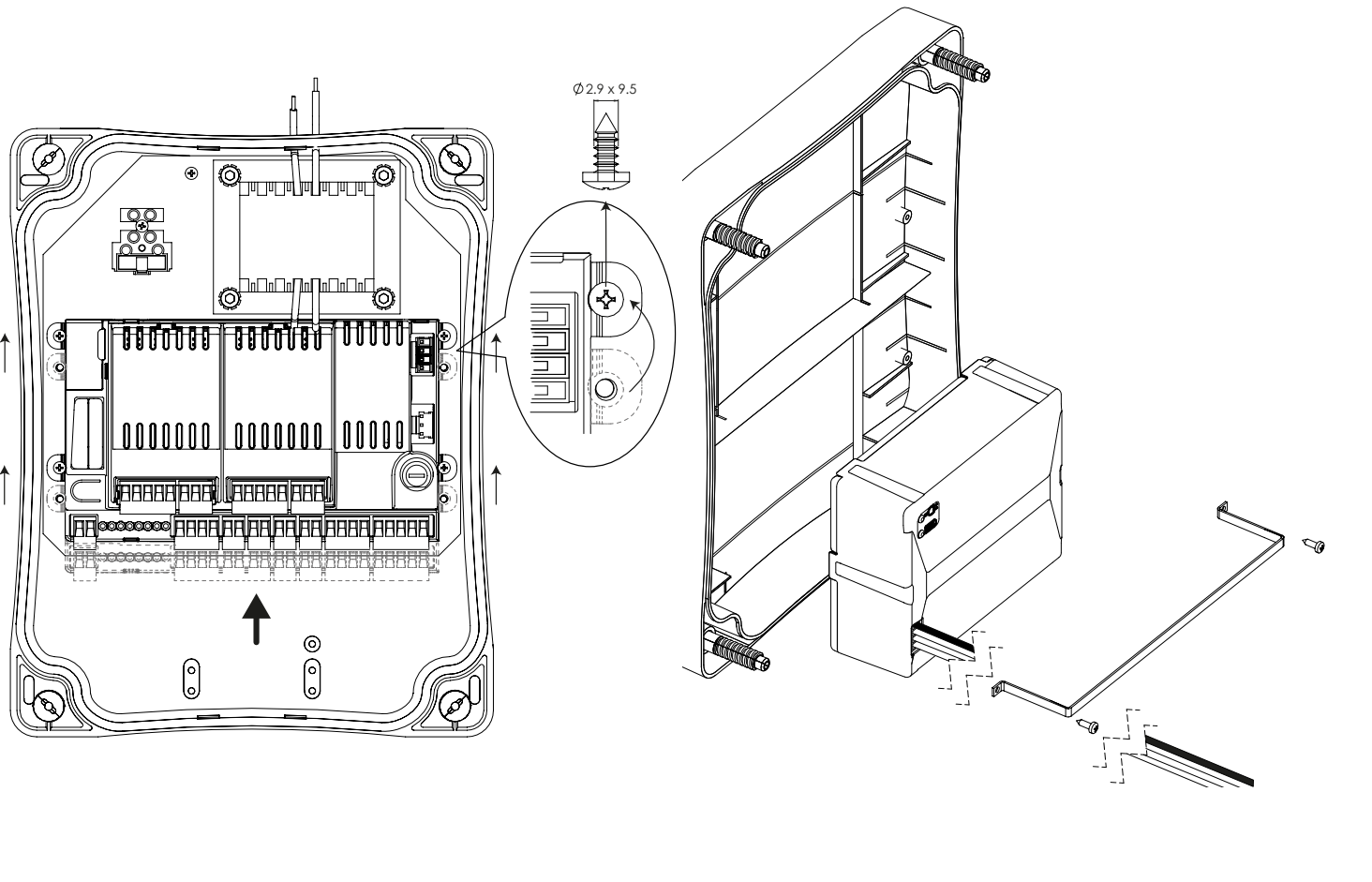
Il sottoscritto Nicola Michelin, Amministratore Delegato dell'azienda
The undersigned Nicola Michelin, General Manager of the company

Key Automation srl, Via Alessandro Volta, 30 - 30020 Noventa di Piave (VE) – ITALIA

dichiara che il prodotto tipo:
declares that the product type:

KBP

Caricabatterie con batterie tampone 1,3Ah al Pb
Battery charger with 1,3Ah Pb backup batteries

Models:
Models:

900KBP

E' conforme a quanto previsto dalle seguenti direttive comunitarie:
Is in conformity with the following community (EC) regulations:

Direttiva bassa tensione / *Low voltage Directive 2006/95/EC*
Direttiva compatibilità elettromagnetica / *EMC Directive 2004/108/EC*

Secondo quanto previsto dalle seguenti norme armonizzate:
In accordance with the following harmonized standards regulations:

EN 61000-6-2:2005
EN 61000-6-3:2007
EN 60335-1:2013

Dichiara inoltre che gli accumulatori utilizzati nel presente prodotto sono ermetici e conformi alla disposizione A67 del regolamento IATA/ICAAO per le merci pericolose. Per questo motivo il trasporto può avvenire senza pericolo per via aerea, su strada o via mare.

He also declares that the batteries used on this product are hermetically sealed and compliant to the A67 provision of the IATA/ICAAO regulation for hazardous goods. Therefore the product can be transported free of risks by air, by sea or on land.

Dichiara che la documentazione tecnica pertinente al prodotto è stata redatta conformemente a quanto previsto dalla direttiva 2006/42/CE Allegato VII parte B e verrà fornita a fronte di una richiesta adeguatamente motivata dalle autorità nazionali.

Declares that the technical documentation is compiled in accordance with the directive 2006/42/EC Annex VII part B and will be transmitted in response to a reasoned request by the national authorities.

Noventa di Piave (VE), 20/03/14

Amministratore Delegato
General Manager
Nicola Michelin



Key Automation S.r.l.
Via A. Volta, 30
30020 Noventa di Piave (VE)
P.IVA 03627650264 C.F. 03627650264
info@keyautomation.it

Capitale sociale 100.000 € i.v.
Reg. Imprese di Venezia 03627650264
REA VE 326953
www.keyautomation.it



Organizzazione con sistema di gestione certificato
ISO 9001:2008

Key Automation S.r.l.

Via A. Volta 30 - 30020 Noventa di Piave (VE)
T. +39 0421.307.456 - F. +39 0421.656.98
info@keyautomation.it - www.keyautomation.it

Instruction version
580ISKBP rev.02